



Wallmount Cabinets

Canovate Wallmount cabinets are designed to ensure professional cable management and easy access inside the cabinet for installers. We are offering a wide range of wallmount enclosures for every type of application to be required in small and medium scale networks.

Wallmount Cabinets

Slim Line Wallmount Cabinet

Technical Features

Material	1,2 mm steel
Color	RAL 7035 or RAL 9005
Maximum Static Load	Up to 75 kg.
Finish	Electrostatic Powder Paint

Standard Configuration:

- ✓ Steel frame
- ✓ Glass door with cylindrical lock
- ✓ Slim line solution for restricted areas
- ✓ 1 Pair of heavy duty 19" mounting rails
- ✓ RoHS compliant, UL and Gost-R certificated

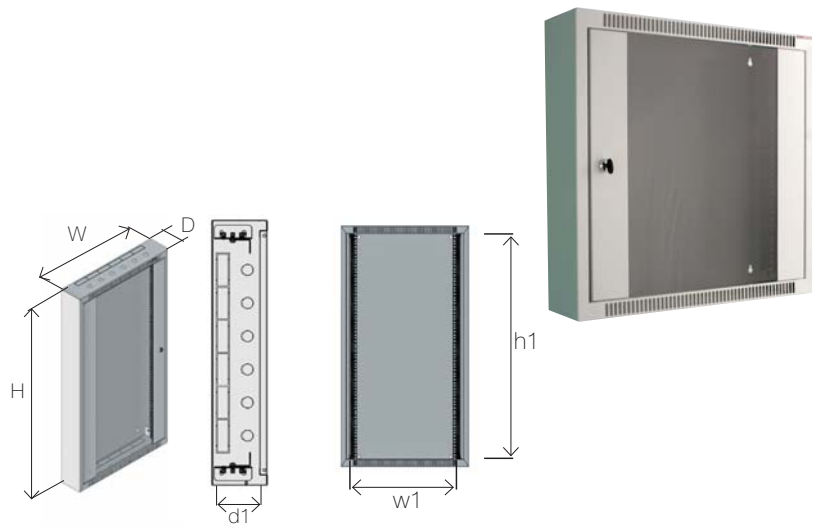

Order Information

Height U	Outer Width (W) mm	Outer Depth (D) mm	Outer Height (H) mm	Inner Width (w1) mm	Inner Depth (d1) mm	Inner Height (h1) mm	Weight kg	Part No
12	600	150	599	525	113	534	12,3	WKF-X-1261A
15	600	150	733	525	113	667	14,6	WKF-X-1561A
24	600	125	1133	525	85	1067	20,7	WKF-X-2461A

X (Color code): 7:RAL 7035 Light Grey, 9:RAL 9005 Black

Wallmount Cabinets

19" SOHO Cabinet

Technical Features

Material	1,2 mm steel
Color	RAL 7035 or RAL 9005
Maximum Static Load	Up to 50 kg.
Finish	Electrostatic Powder Paint

Standard Configuration:

- ✓ Steel frame
- ✓ Glass door with cylindrical lock
- ✓ 1 Pair of heavy duty 19" mounting rails
- ✓ Flatpack option available
- ✓ Low cost alternative
- ✓ RoHS compliant, UL and Gost-R certified

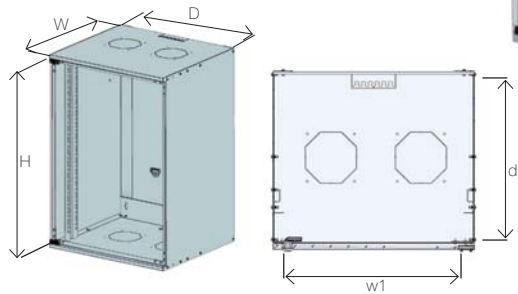

Order Information

Height U	Outer Width (W) mm	Outer Depth (D) mm	Outer Height (H) mm	Inner Width (w1) mm	Inner Depth (d1) mm	Inner Height (h1) mm	Weight kg	Part No
6	500	450	350	478	422	275	5,89	WCS-X-0654A
9	500	450	469	478	422	408	7,97	WCS-X-0954A
12	500	450	603	478	422	543	10,05	WCS-X-1254A

X (Color code): 7:RAL 7035 Light Grey, 9:RAL 9005 Black

10" SOHO Cabinet

Technical Features

Material	1,2 mm steel
Color	RAL 7035 or RAL 9005
Maximum Static Load	Up to 50 kg.
Finish	Electrostatic Powder Paint

Standard Configuration:

- ✓ Steel Frame
- ✓ Glass door with cylindrical lock
- ✓ Openable side panels
- ✓ 1 Pair of heavy duty 10" mounting rails
- ✓ RoHS compliant, UL and Gost-R certified

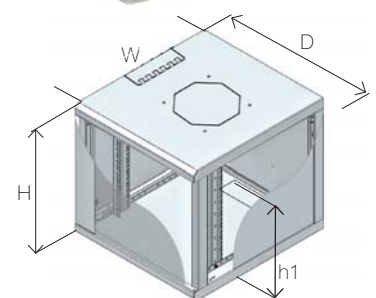
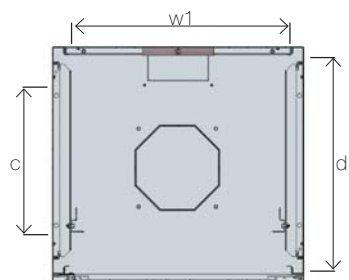

Order Information

Height U	Outer Width (W) mm	Outer Depth (D) mm	Outer Height (H) mm	Inner Width (w1) mm	Inner Depth (d1) mm	Inner Height (h1) mm	Weight kg	Part No
6	316	310	350			177	17	WCT-X-0633A

X (Color code): 7:RAL 7035 Light Grey, 9:RAL 9005 Black

Wallmount Cabinets

Flatpack Single Wallmount with Openable Side Panels From Inside

Technical Features

Material	1,2 mm steel
Color	RAL 7035 or RAL 9005
Maximum Static Load	Up to 70 kg.
Finish	Electrostatic Powder Paint

Standard Configuration:

- ✓ Steel frame
- ✓ Glass door with cylindrical lock
- ✓ Openable side panels from inside for security
- ✓ 1 Pair of heavy duty 19" mounting rails
- ✓ Flatpack option available
- ✓ RoHS compliant, UL and Gost-R Certificated

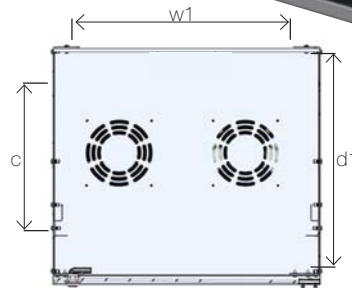

Order Information

Height U	Outer Width (W) mm	Outer Depth (D) mm	Outer Height (H) mm	Inner Width (w1) mm	Inner Depth (d1) mm	Inner Height (h1) mm	19" Rails Adjustable Depth Range (c)	Weight kg	Part No
6	600	400	366	510	360	266	110-305	21,36	WSN-X-0664F
6	600	560	366	510	520	266	110-465	24,26	WSN-X-0665F
9	600	400	488	510	360	408	110-305	24,62	WSN-X-0964F
9	600	560	488	510	520	408	110-465	27,82	WSN-X-0965F
12	600	400	621	510	360	541	110-305	28,01	WSN-X-1264F
12	600	560	621	510	520	541	110-465	31,65	WSN-X-1265F
15	600	400	755	510	360	674	110-305	31,40	WSN-X-1564F
15	600	560	755	510	520	674	110-465	35,49	WSN-X-1565F
18	600	400	888	510	360	808	110-305	34,81	WSN-X-1864F
18	600	560	888	510	520	808	110-465	39,33	WSN-X-1865F
21	600	400	1022	510	360	942	110-305	38,20	WSN-X-2164F
21	600	560	1022	510	520	942	110-465	43,16	WSN-X-2165F

X (Color code): 7:RAL 7035 Light Grey, 9:RAL 9005 Black

Double Section Wallmount Cabinet

Technical Features

Material	1,5 mm steel
Color	RAL 7035 or RAL 9005
Maximum Static Load	Up to 100 kg.
Finish	Electrostatic Powder Paint

Standard Configuration:

- ✓ Steel frame
- ✓ Glass door with cylindrical lock
- ✓ Accessible from rear side with double hinged design
- ✓ 1 Pair of heavy duty 19" Mounting Rails
- ✓ RoHS compliant, UL and Gost-R Certificated

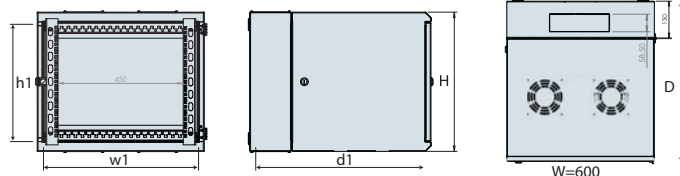

Order Information

Height U	Outer Width (W) mm	Outer Depth (D) mm	Outer Height (H) mm	Inner Width (w1) mm	Inner Depth (d1) mm	Inner Height (h1) mm	19" Rails Adjustable Depth Range (c)	Weight kg	Part No
6	600	300+150	366	530	260+120	266	110-205	20,23	WS2D -X-0664A
6	600	500+150	366	530	460+120	266	110-405	22,4	WS2D -X-0666A
9	600	300+150	500	530	260+120	400	110-205	29,93	WS2D -X-0964A
9	600	500+150	500	530	460+120	400	110-405	32,44	WS2D -X-0966A
12	600	300+150	632	530	260+120	532	110-205	38,67	WS2D -X-1264A
12	600	500+150	632	530	460+120	532	110-405	42,87	WS2D -X-1266A
15	600	300+150	766	530	260+120	666	110-205	46,34	WS2D -X-1564A
15	600	500+150	766	530	460+120	666	110-405	52,61	WS2D -X-1566A
18	600	300+150	900	530	260+120	800	110-205	55,46	WS2D -X-1864A
18	600	500+150	900	530	460+120	800	110-405	62,9	WS2D -X-1866A
21	600	300+150	1034	530	260+120	934	110-205	64,67	WS2D -X-2164A
21	600	500+150	1034	530	460+120	934	110-405	72,43	WS2D -X-2166A

X (Color code): 7:RAL 7035 Light Grey, 9:RAL 9005 Black

Wallmount Cabinets

Single Wallmount with Openable Side Panels From Inside

Technical Features

Material	1,2 mm steel
Color	RAL 7035 or RAL 9005
Maximum Static Load	Up to 70 kg.
Finish	Electrostatic Powder Paint

Standard Configuration:

- ✓ Steel frame
- ✓ Glass door with cylindrical lock
- ✓ Openable side panels from inside for security
- ✓ 1 Pair of heavy duty 19" mounting rails
- ✓ Flatpack option available
- ✓ RoHS compliant, UL and Gost-R Certificated

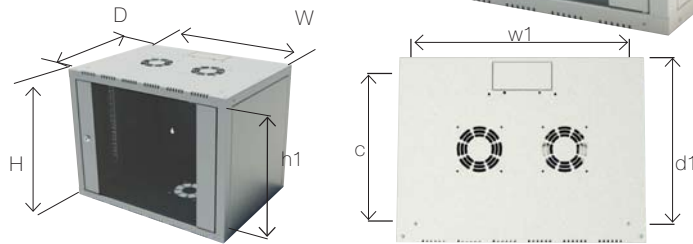

Order Information

Height U	Outer Width (W) mm	Outer Depth (D) mm	Outer Height (H) mm	Inner Width (w1) mm	Inner Depth (d1) mm	Inner Height (h1) mm	19" Rails Adjustable Depth Range (c)	Weight kg	Part No
6	600	400	366	510	360	266	110-305	21,36	WS2N-X-0664A
6	600	560	366	510	520	266	110-465	24,26	WS2N-X-0665A
9	600	400	488	510	360	408	110-305	24,62	WS2N-X-0964A
9	600	560	488	510	520	408	110-465	27,82	WS2N-X-0965A
12	600	400	621	510	360	541	110-305	28,01	WS2N-X-1264A
12	600	560	621	510	520	541	110-465	31,65	WS2N-X-1265A
15	600	400	755	510	360	674	110-305	31,4	WS2N-X-1564A
15	600	560	755	510	520	674	110-465	35,49	WS2N-X-1565A
18	600	400	888	510	360	808	110-305	34,81	WS2N-X-1864A
18	600	560	888	510	520	808	110-465	39,33	WS2N-X-1865A
21	600	400	1022	510	360	942	110-305	38,2	WS2N-X-2164A
21	600	560	1022	510	520	942	110-465	43,16	WS2N-X-2165A

X (Color code): 7:RAL 7035 Light Grey, 9:RAL 9005 Black

Flatpack Single Wallmount Cabinet with Openable Side Panels From Outside

Technical Features

Material	1,2 mm steel
Color	RAL 7035 or RAL 9005
Maximum Static Load	Up to 100 kg.
Finish	Electrostatic Powder Paint

Standard Configuration:

- ✓ Steel frame
- ✓ Glass door with cylindrical lock
- ✓ Openable side panels with cylindrical lock
- ✓ 1 Pair of heavy duty 19" mounting rails
- ✓ RoHS compliant, UL and Gost-R Certificated
- ✓ Standard Flatpack
- ✓ Color RAL 7035 or RAL 9005

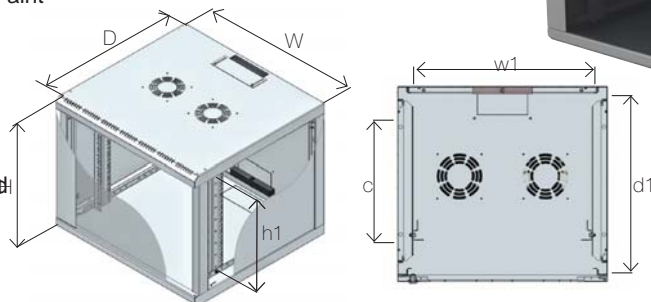

Order Information

Height U	Outer Width (W) mm	Outer Depth (D) mm	Outer Height (H) mm	Inner Width (w1) mm	Inner Depth (d1) mm	Inner Height (h1) mm	19" Rails Adjustable Depth Range (c)	Weight kg	Part No
6	600	400	366	510	360	266	110-305	22,25	WSO-X-0664F
6	600	560	366	510	520	266	110-465	25,27	WSO-X-0665F
9	600	400	488	510	360	408	110-305	25,6	WSO-X-0964F
9	600	560	488	510	520	408	110-465	28,93	WSO-X-0965F
12	600	400	621	510	360	541	110-305	29,13	WSO-X-1264F
12	600	560	621	510	520	541	110-465	32,92	WSO-X-1265F
15	600	400	755	510	360	674	110-305	32,66	WSO-X-1564F
15	600	560	755	510	520	674	110-465	36,91	WSO-X-1565F
18	600	400	888	510	360	808	110-305	36,2	WSO-X-1864F
18	600	560	888	510	520	808	110-465	40,9	WSO-X-1865F
21	600	400	1022	510	360	942	110-305	39,73	WSO-X-2164F
21	600	560	1022	510	520	942	110-465	44,89	WSO-X-2165F

X (Color code): 7:RAL 7035 Light Grey, 9:RAL 9005 Black

Wallmount Cabinets

Single Wallmount with Openable Side Panels From Outside

Technical Features

Material	1,2 mm steel
Color	RAL 7035 or RAL 9005
Maximum Static Load	Up to 100 kg.
Finish	Electrostatic Powder Paint

Standard Configuration:

- ✓ Steel frame
- ✓ Glass door with cylindrical lock
- ✓ Openable side panels from outside
- ✓ 1 Pair of heavy duty 19" Mounting Rails
- ✓ RoHS compliant, UL and Gost-R Certificated



Order Information

Height U	Outer Width (W) mm	Outer Depth (D) mm	Outer Height (H) mm	Inner Width (w1) mm	Inner Depth (d1) mm	Inner Height (h1) mm	19" Rails Adjustable Depth Range (c)	Weight kg	Part No
6	600	400	366	510	360	266	110-305		WS20-X-0664A
6	600	560	366	510	520	266	110-465		WS20-X-0665A
9	600	400	488	510	360	408	110-305		WS20-X-0964A
9	600	560	488	510	520	408	110-465		WS20-X-0965A
12	600	400	621	510	360	541	110-305		WS20-X-1264A
12	600	560	621	510	520	541	110-465		WS20-X-1265A
15	600	400	755	510	360	674	110-305		WS20-X-1564A
15	600	560	755	510	520	674	110-465		WS20-X-1565A
18	600	400	888	510	360	808	110-305		WS20-X-1864A
18	600	560	888	510	520	808	110-465		WS20-X-1865A
21	600	400	1022	510	360	942	110-305		WS20-X-2164A
21	600	560	1022	510	520	942	110-465		WS20-X-2165A

X (Color code): 7:RAL 7035 Light Grey, 9:RAL 9005 Black

Single Wallmount Cabinet with Fixed Side Panels

Technical Features

Material	1,2 mm steel
Color	RAL 7035 or RAL 9005
Maximum Static Load	Up to 100 kg.
Finish	Electrostatic Powder Paint

Standard Configuration:

- ✓ Steel frame
- ✓ Glass door with cylindrical lock
- ✓ Fixed side panel
- ✓ 1 Pair of heavy duty 19" Mounting Rails
- ✓ RoHS compliant, UL and Gost-R Certificated



Order Information

Height U	Outer Width (W) mm	Outer Depth (D) mm	Outer Height (H) mm	Inner Width (w1) mm	Inner Depth (d1) mm	Inner Height (h1) mm	19" Rails Adjustable Depth Range (c)	Weight kg	Part No
6	600	400	366	510	360	266	110-305	22,25	WS2F-X-0664A
6	600	560	366	510	520	266	110-465	25,27	WS2F-X-0665A
9	600	400	488	510	360	408	110-305	25,6	WS2F-X-0964A
9	600	560	488	510	520	408	110-465	28,93	WS2F-X-0965A
12	600	400	621	510	360	541	110-305	29,13	WS2F-X-1264A
12	600	560	621	510	520	541	110-465	32,92	WS2F-X-1265A
15	600	400	755	510	360	674	110-305	32,66	WS2F-X-1564A
15	600	560	755	510	520	674	110-465	36,91	WS2F-X-1565A
18	600	400	888	510	360	808	110-305	36,2	WS2F-X-1864A
18	600	560	888	510	520	808	110-465	40,9	WS2F-X-1865A
21	600	400	1022	510	360	942	110-305	39,73	WS2F-X-2164A
21	600	560	1022	510	520	942	110-465	44,89	WS2F-X-2165A

X (Color code): 7:RAL 7035 Light Grey, 9:RAL 9005 Black